

# nuna®

MODEL CF-06-001AU

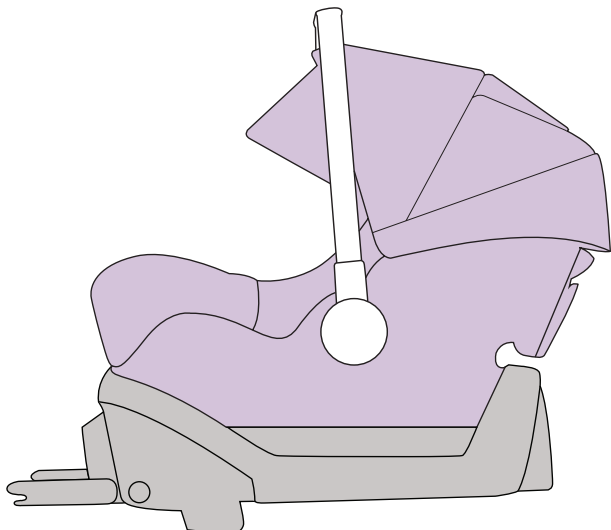

# pipa™ klik

instructions

IMPORTANT: KEEP THIS INSTRUCTION BOOKLET IN THE PLACE PROVIDED ON THE CHILD RESTRAINT

# Smart Design

**We like design.**

**And people who like design get us.**

**We will not embarrass your kids.**

**We cannot promise they will stay clean.**

**But we know it will all be okay. We are parents.**

**We are Nuna.**



# Contents

Quick Reference	2-3
<b>WARNINGS</b>	4
Additional Warnings	5-7
Features	8-9
Securing Child in the Restraint	10-12
Shoulder Strap Height	13-15
Crotch Strap Position	16
Canopy Removal	16
Accessories	17-19
Infant Insert	20
Carry Handle	21
The Next Restraint	22
Installation – General	23-24
Installation – Vehicle Belts	25-26
Installation – ISOFIX Compatible Connectors	27-29
Storage – ISOFIX Compatible Connectors	30
Installation – Restraint to Base	31
<b>WARNINGS – Top Tether</b>	32
Tether Strap Use	33
Installation – Tether Anchorage	34-36
Use with Strollers	37
Cleaning and Maintenance	38-39

DO NOT USE THIS CHILD RESTRAINT UNTIL YOU HAVE READ AND UNDERSTOOD THE INSTRUCTIONS IN THIS USER GUIDE AND IN YOUR VEHICLE OWNERS MANUAL

# Quick Reference – Use

**IMPORTANT:** After reading this Quick Reference read the following instructions carefully

## Shoulder Straps

must always be at correct height and pulled tight.  
See pages 13–15

## Head Liners and Infant Insert

only use for smaller children who require more support.  
See page 20

## Shoulder Height

shoulders must not be above the marker line  
See page 14

## Harness Straps

must not be twisted.  
See page 15

## Harness Buckle

must always be securely fastened.  
See page 11

## Harness Tension

pull harness tight.  
See page 11

## Suitable Clothing

child's clothing must not interfere with the harness  
See page 12

## Child Position

child must be in full contact with back of restraint.  
See page 10

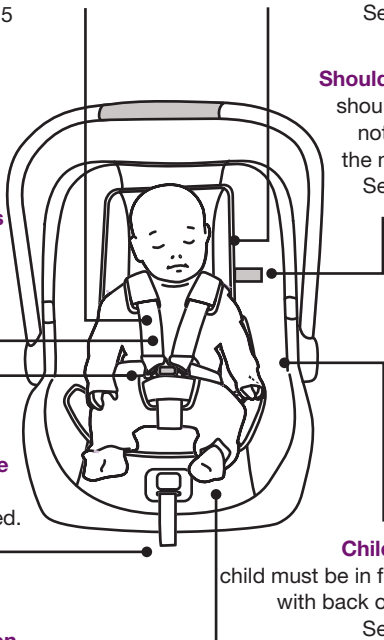

This Child Restraint is suitable for children up to approximately 6 months of age. See page 5 for more detailed information.

# Quick Reference – Restraint and Base

**IMPORTANT:** After reading this Quick Reference read the following instructions carefully

## Tether Strap

must always be used when the restraint is installed in a vehicle. Store end of tether in bag. See page 32

## Carry Handle

must always be locked into position. See page 21

## Secure Latching

restraint must be securely latched into base. See page 31

## Vehicle Belt (if used)

must always be secure and pulled tight. See pages 24–26

## Base Recline Adjustment

base must be reclined correctly See pages 24 & 29

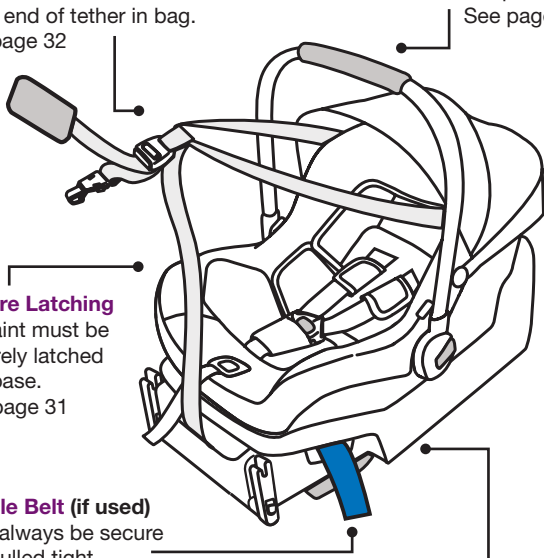

Read the whole of these instructions carefully and if there is any doubt about the method of installation, consult the child restraint manufacturer or agent, or a child restraint fitting station authorized by the relevant transport authority, or in New Zealand an agent for the vehicle.



## **WARNING**

- Use the restraint exactly as shown in the instructions.
- Supervision of children is needed because they may be able to undo buckles.
- To ensure that baby's back is evenly supported, do not put more than one nappy on the baby and make sure the nappy is not folded thickly at the back.
- Do not allow the restraint to come into contact with polishes, oils, bleach and other chemicals.
- Destroy the restraint if it has been in a severe crash, even if no damage is visible.
- Repairs must only be done by the manufacturer or agent.
- Fit the harness firmly to the child.
- A loose harness or restraint is dangerous.
- Fit the restraint firmly to the car seat.
- Do not alter or modify this restraint.
- Do not harness an infant wrapped in a blanket or swaddled. Any blanket or wrap must only be placed over the harness and infant.
- **DO NOT USE THIS RESTRAINT WITHOUT THE COVER.**
- **DO NOT USE A REAR FACING CHILD RESTRAINT WHERE AN AIRBAG IS FITTED IN FRONT OF THE SEATING POSITION.**



## **WARNING**

**DO NOT LEAVE CHILDREN UNATTENDED IN THE CAR**



## ADDITIONAL WARNINGS

This Child Restraint is:

To be used only in a rearward-facing position until the infant's shoulders reach the shoulder height marker (approximately 6 months of age).

Continue to use this infant restraint until the child reaches this limit.

Infants are at risk of serious injury if they face forward too early.

**TO BE USED WITH A LAP-SASH/LAP ONLY SEATBELT OR ISOFIX LOW ANCHORAGES IN THE BACK OF MOST CARS WITH FORWARD FACING SEATS.**

This restraint is 700 mm long, 440 mm wide and 480 mm high (with the handle down). Check the measurement between the front of the seat back of the rear seat and all front seats in the car in which the restraint is intended to be used to ensure the space available is sufficient.

Ensure that children have adequate ventilation and shade when in the vehicle.

Seat belt extenders are not recommended if the car seat belt is too short to secure the child restraint.

If the car seat belt is too short get advice from a child restraint fitter regarding use of these.

Read carefully the whole of the instructions for the installation, and in the event of doubt about the method of installation, consult the child restraint manufacturer or agent, or a child restraint fitting station authorized by the relevant transport authority, or in New Zealand, consult the agent for the vehicle.

**NOTE:** The warnings on these two pages are those required by the Australian and New Zealand Standard AS/NZS 1754 for this type of child restraint. Other warnings specific to this particular child restraint will be found on the following pages and throughout these instructions.



## ADDITIONAL WARNINGS

When baby is in the restraint, ALWAYS secure the harness and adjust to a firm fit.

Always check buckle and other parts for hot surfaces. A child restraint left uncovered in the sun could burn a child. Cover with blanket if leaving in car.

Do not use the child restraint if any harness straps are cut, frayed or damaged.

Do not use any products or accessories in conjunction with the child restraint not supplied with child restraint.

Fall hazard: Child's movement can slide carrier. NEVER place child restraint near edges of countertops, tables or other high surfaces. Always stay within arms reach whenever child restraint is not on floor/ground.

Suffocation hazard: child restraint can roll over on soft surfaces and suffocate child. Never place child restraint on beds, sofas, or other soft surfaces.

Strangulation hazard: Child can strangle in loose child restraint straps. Always use harness. Never leave child in the child restraint when straps are loose or undone.

Harness straps should be snug. A snug strap should not allow any slack. It lies in a relatively straight line without sagging. It does not press on the child's flesh or push the child's body into an unnatural position.

Never place the child restraint on top of a shopping cart. The child restraint will not be properly secured and could fall.

Do not use the child restraint if it is damaged or broken.

Only use with Nuna strollers or appropriate Nuna adapters designed for use with other strollers.



## **ADDITIONAL WARNINGS**

Always check child restraint to base connection.

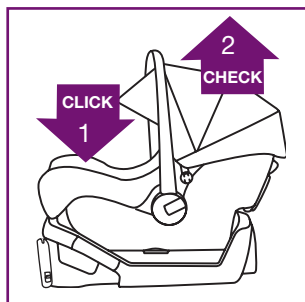

Only install child restraint in a forward facing vehicle seat. Never install in a seat that faces the rear or the side of the vehicle.

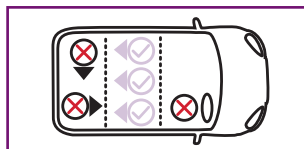

This is a rearward facing child restraint. Do not install facing side or forwards.

Never install the Child Restraint in a seat with a front airbag. **DEATH** or **SERIOUS INJURY** may occur. Refer to your vehicle Owners Manual for airbag warnings and information.



# Features — Child Restraint

- |   |                         |    |                         |
|---|-------------------------|----|-------------------------|
| 1 | Carry Handle            | 8  | Carry Handle Lock       |
| 2 | Infant Insert           | 9  | Harness Straps          |
| 3 | Shoulder Pads           | 10 | Seat Cover              |
| 4 | Buckle and Crotch Belt  | 11 | Stroller Release Handle |
| 5 | Harness Adjuster Button | 12 | Shoulder Strap Slots    |
| 6 | Harness Adjuster Strap  | 13 | Base Attachment Bars    |
| 7 | Canopy                  | 14 | Splitter Plate          |

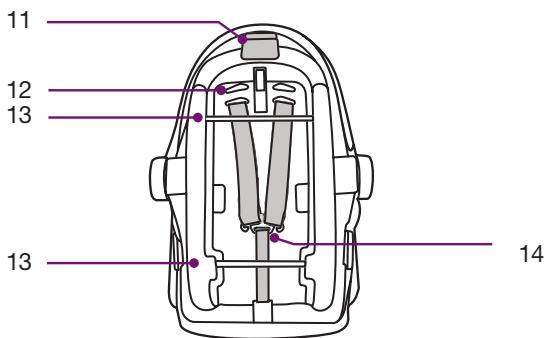
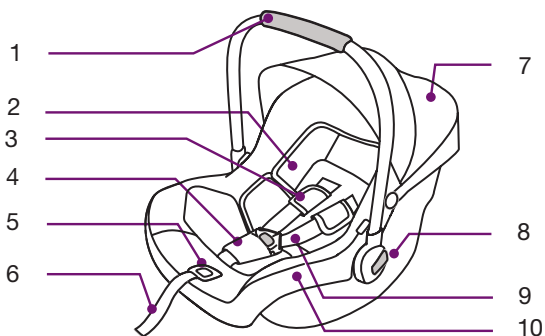

# Features — Base

- 15 Tether Strap
- 16 Child Restraint Release Lever
- 17 Tether Strap Anchorage
- 18 Vehicle Belt Lock-Off
- 19 Bubble Level Indicator
- 20 Instruction Manual Storage
- 21 Recline Foot
- 22 ISOFIX connector
- 23 Recline Foot Fold Latch
- 24 ISOFIX connector fold latch

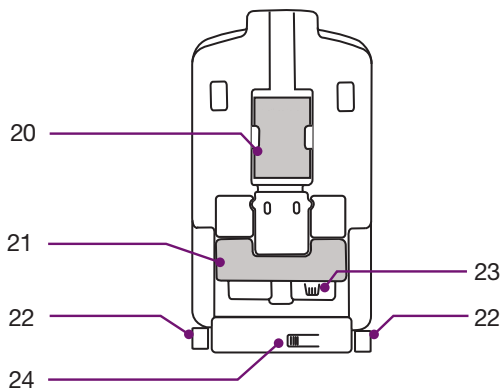
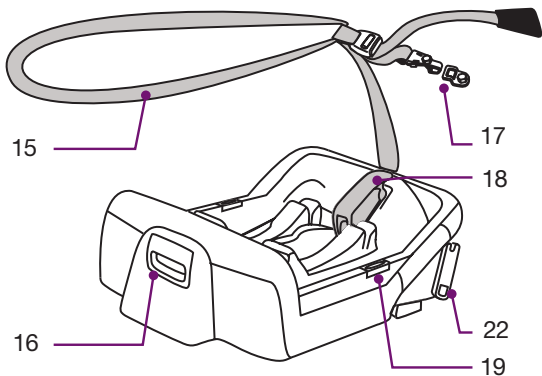

# Securing Child in the Restraint

FIRST CHECK SHOULDER STRAP HEIGHT AND ADJUST IF NECESSARY. See page 13

- 1 Loosen harness by pressing on adjuster button while pulling on the harness straps.

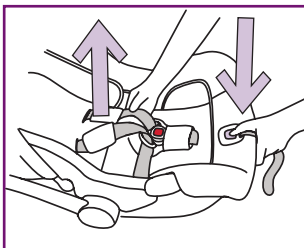

- 2 Press button to open the quick release buckle. Spread harness straps apart.

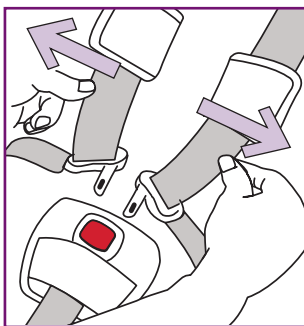

- 3 Place child in restraint in seated position, firmly against both the back and bottom of the restraint.

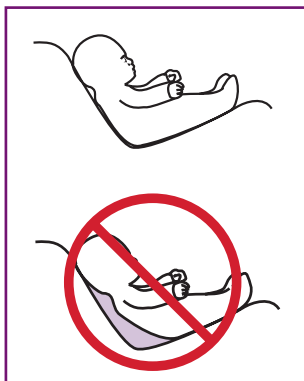

- 4 Place buckle tongues into the quick release buckle.  
**IMPORTANT:** The buckle tongue pushed in last should "CLICK" when it locks into place. If it does not click, try again or try cleaning the buckle. See page 39.

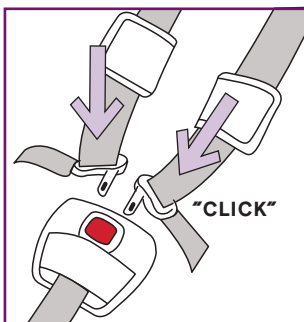

- 5 Tighten harness by pulling on the adjuster strap at the front of the restraint.

**IMPORTANT:** Shoulder Straps must be a firm or snug fit.

Note: you may need to pull excess shoulder strap webbing through the Quick Release Buckle Tongues upward towards the child's shoulder and then pull on the adjuster strap. This may need to be repeated several times to get the webbing fitting snugly.

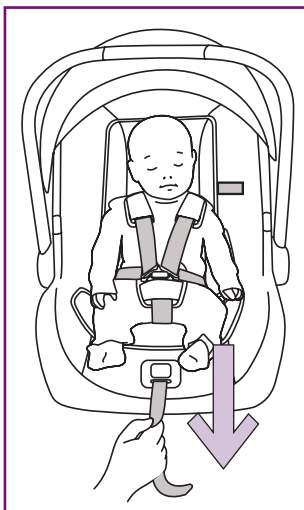

**WARNING**

**DO NOT LEAVE CHILDREN UNATTENDED IN THE CAR**

- 6 Check that the harness is snug around the child's waist and shoulders.

### **Blankets**

Never use blankets or clothing that interfere with the harness as a poorly secured child can come out of the restraint during a crash. Only place blankets over child AFTER harness has been properly tightened.

### **Swaddling**

Infants need to be securely held by the harness. An infant wrapped in a blanket or swaddled will not be securely held and may be ejected and killed in an accident

Do not bind or wrap the infants arms or legs together.



# Shoulder Strap Height

Correct positioning of the shoulder straps is essential for your baby's safety.

## Requirement

The shoulder straps must be in the slots that are nearest to the child's shoulders, but not lower than the child's shoulders.

The straps should be in the next available shoulder strap slots above your baby's shoulders.

## To Check

- 1 With child placed in the restraint, note where the shoulder straps enter the slots in the backrest. If adjustment is needed follow the next steps.

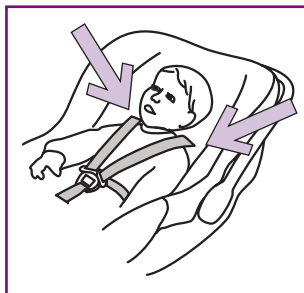

## To Adjust

- 2 With child removed, loosen harness. Turn carrier over and remove one shoulder strap harness loop from the metal splitter plate.

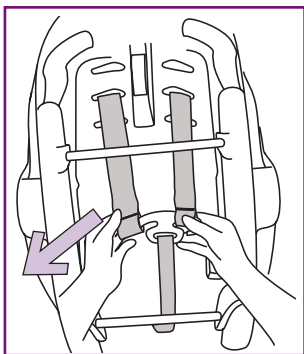

3 Pull loose end of harness loop out through slot and place in correct slot.

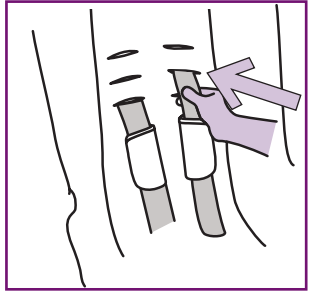

4 Re-attach to splitter plate.

5 Repeat with the other shoulder strap.

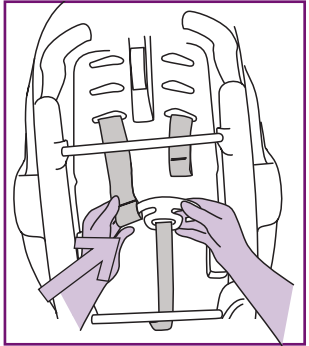

This restraint has a shoulder height level label. Use this to gauge when your child is too big for the restraint. Once your child's shoulders reach the dotted line, it is time to move to a bigger restraint. See page 22.





The shoulder straps must pass under the steel bars at the back of the restraint.

**IMPORTANT:**

Shoulder Straps must not be twisted.

Always adjust the height of the shoulder straps as the child grows,

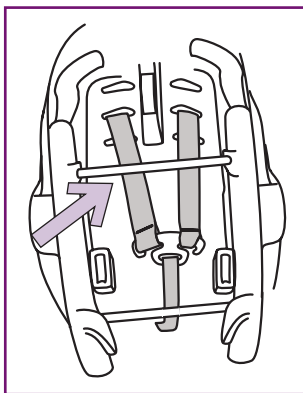

They must not pass over the outside of the steel bars at the back of the restraint.

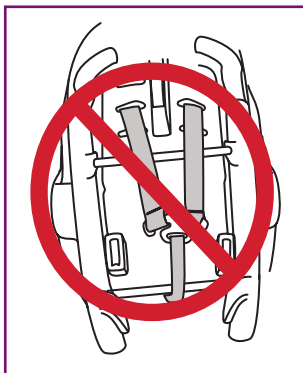

**IMPORTANT:** if the baby's neck muscles are unable to support their head, they should remain rear facing.

# Crotch Strap Position

There are two positions available for the crotch strap.

The rear position is recommended for normal use and the front position with a bigger child.

The steel buckle must be fully through the slot.

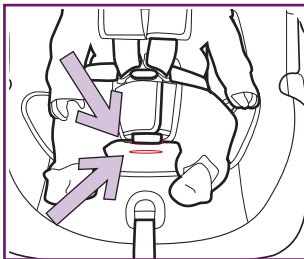

**IMPORTANT:** After changing the strap position pull firmly upward on the crotch strap to check the buckle is securely fitted.

View from underneath the shell—check the buckle is fully through the slot.

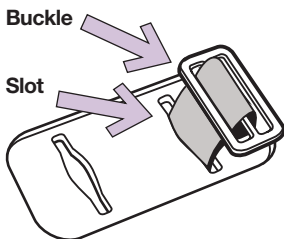

# Canopy

## Canopy Removal

To remove the canopy, press the buttons in the canopy mounts and pull the canopy bow out.

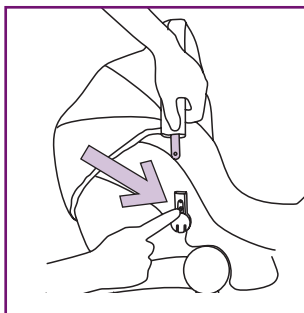

# Accessories

DO NOT add accessories, toys, padding or other items to the child restraint unless provided by Nuna.

Aftermarket accessories (i.e. items not provided in the box with the child restraint), may not have been tested for use with this child restraint and if used, may lower the level of protection offered possibly leading to injury or death.

Any aftermarket accessory used should be compliant with AS/NZS 8005 (Accessories for child restraints for use in motor vehicles) and stated as suitable for use with this child restraint.

## Dream Drape (out of vehicle use only)

- 1 Unzip the zipper behind the front canopy bow.
- 2 Pull the dream drape out of the compartment.
- 3 Attach the magnets on each corner to the corner to the front of the restraint.

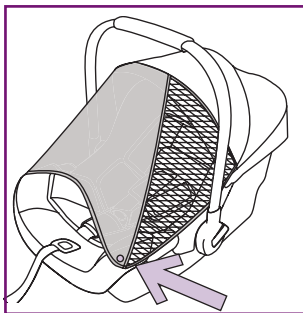
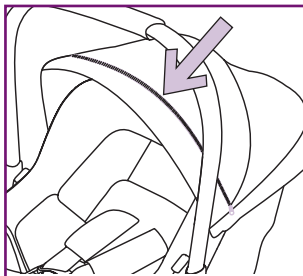

**IMPORTANT:** Do not use the Dream Drape in a vehicle as it will interfere with the tether strap.

## Seat Cover Removal

- 1 Pull the fastening pieces underneath the edge of the seat out.

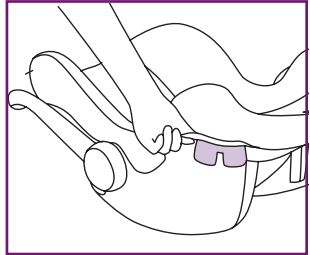

- 2 Remove the harness from the splitter plate.

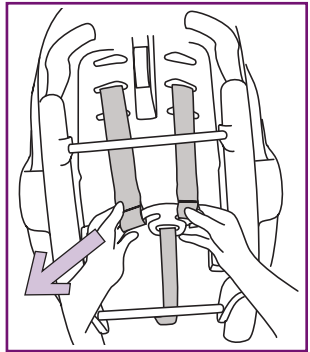

- 3 Remove the seat cover from the adjustment button as shown.

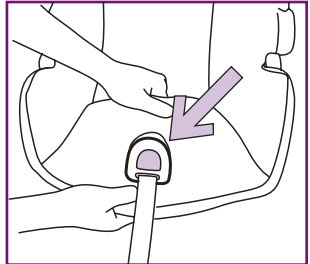

- 4 Remove the seat pad from the stroller release button as shown.

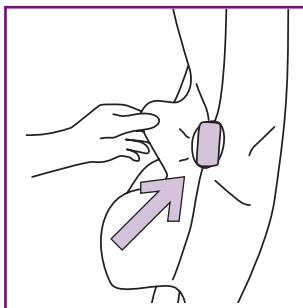

**VERY IMPORTANT:** Only replace the cover with a Nuna supplied replacement cover with identical shoulder height markers or a replacement cover meeting AS/NZS 8005.

### Shoulder Pads and Head Liner

Shoulder pads and head liner are removable and are not necessary for safety.



# Infant Insert

The infant insert can be used to provide a snug fit for smaller babies.

In the back of the liner is an extra foam pad intended for use with low birth weight or very small babies. This should be removed when they are bigger.

Remove the infant insert from the child restraint once the baby is bigger.

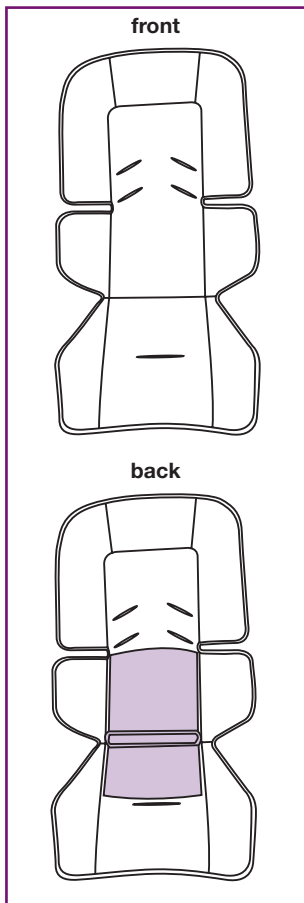

# Carry Handle

The carry handle can be adjusted to 3 positions.

- 1 To adjust the handle position, squeeze handle buttons on both sides and rotate.
- 2 Rotate handle until it clicks into any of the 3 positions.

The carry handle can be used in a vehicle in any locked position.

Be sure handle is locked in the carry position before lifting carrier by handle. An unlocked handle could move unexpectedly, causing injury to child.

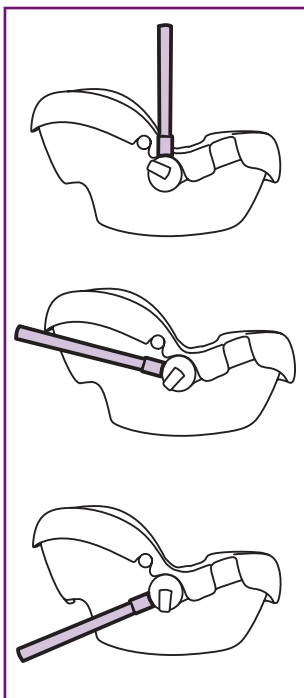
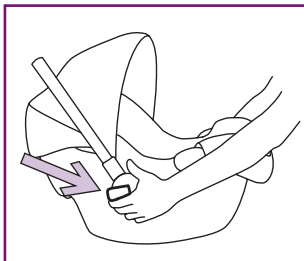

# The Next Restraint

This restraint is suitable for a baby up to approximately 6 months of age. When the baby's shoulders are level with the shoulder height marker (see page 14) they should move to a bigger restraint.

NOTE: although children from approximately the age of 6 months can move to a forward facing restraint, it is preferable if they move first to a convertible style restraint which has been approved for use rearward facing up to the age of approximately 12 months.

Then when the child reaches that age they can change to a forward facing position

The next category of restraint is forward facing and has a six point harness and will be suitable for the child until they are approximately 4 years of age.

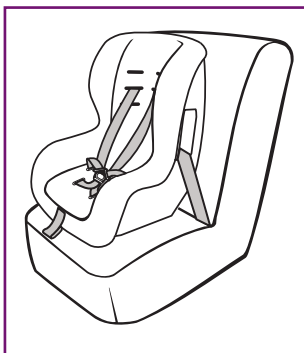



# Installation — General

## Where to install the child restraint?

Only install child restraint in a forward facing vehicle seat. Never install in a seat that faces the rear or the side of the vehicle.

Install in the rear seat, the safest place is normally the centre.

This is a rearward facing child restraint. Do not install facing sideways or forward.

The base can be installed on vehicles seats fitted with either a lap belt or a lap/sash belt or ISOFIX anchorages.

To install correctly the vehicle must be on a level surface.

**IMPORTANT:** Correctly positioning the child restraint is important to ensure that in the event of a crash the restraint can offer maximum protection.

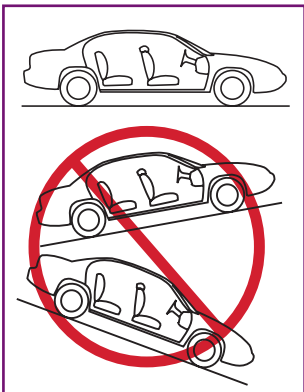
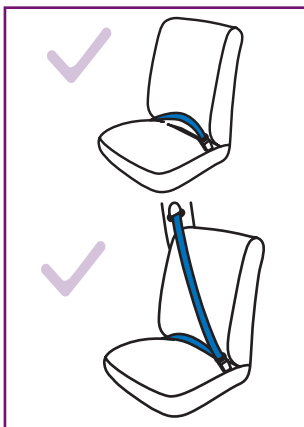
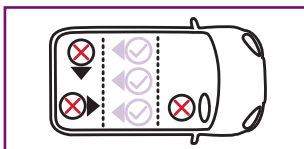

- 1 Position base on a forward facing vehicle seat. Use recline adjustment to position bubble in indicator.

Adjust base so bubble is between the black patches.

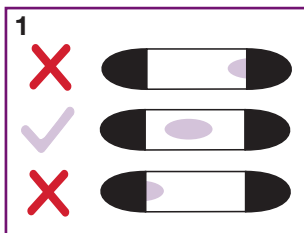

- 2 Use recline adjustment, if needed, to achieve correct angle for installation. Recline adjustment foot snaps into position.

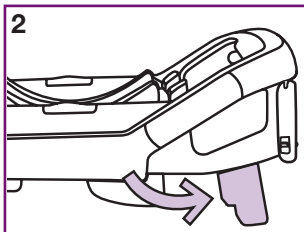

- 3 If the recline adjustment foot does not give sufficient recline, add a folded towel or similar.

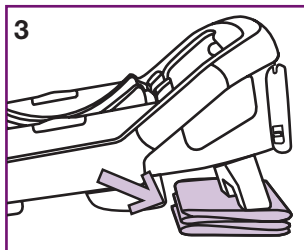

**IMPORTANT:** Any extra padding placed under the base must be firmly folded so that when the vehicle belts are pulled up tight, the base is secure.

# Installation — Vehicle Belts

Place the base on the vehicle seat and route the vehicle belt through the opening in the base labeled 'Belt Path' and buckle the vehicle belt. Both the shoulder and lap belt must be under the blue lock off.

Push the base into the vehicle seat firmly and pull the vehicle belts **TIGHT** before locking them in place.

## REARWARD FACING BELT PATH

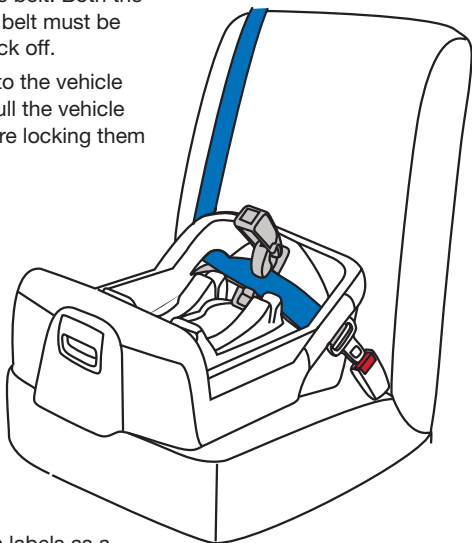

Use the Belt Path labels as a guide for correct belt placement.

**REARWARD FACING  
BELT PATH**



**IMPORTANT:** Always secure the base with a vehicle belt, even when the restraint is not fitted to it. An unsecured base may be dangerous in an accident or sudden stop.

**Check**

- 1 Vehicle belt is securely engaged in buckle.

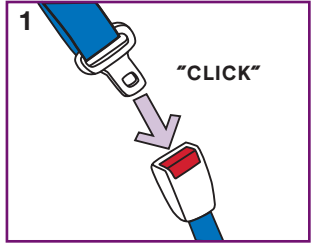

- 2 Vehicle lap belt or lap/sash belts are correctly positioned in the lock-off.

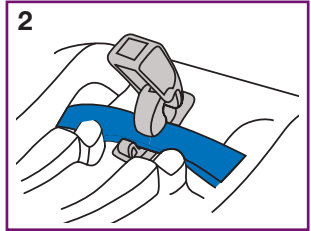

- 3 Vehicle belt lock-off is securely engaged.

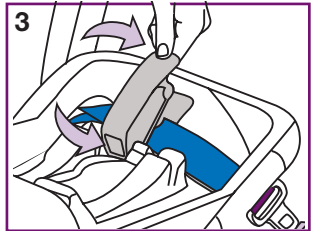

- 4 Level indicator bubble is fully in the clear area.

**IMPORTANT:** Vehicle Belts must be pulled tight. **DO NOT** have any slack in the belts.

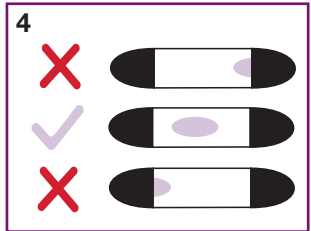

# Installation — ISOFIX Compatible Connectors

**IMPORTANT:** ISOFIX compatible connectors are an option and may not be fitted to your product.

## General

Some vehicles are fitted with low anchorage points specifically designed to allow connection by suitably equipped child restraints.

These are generally known as ISOFIX low anchorage points are found at the bottom of the back seat backrest.

If the ISOFIX low anchorage points are not clearly visible the vehicle seat will be marked with appropriate labels to show their location.

These vehicles are marked with symbols adjacent to the location of the anchorage points.

If in doubt that the vehicle is fitted with such points check the vehicle Owners Manual.

Some vehicles sourced from the USA may be marked LATCH.

ISOFIX and LATCH low anchorage points are identical.



**ISOFIX**

**Typical marking showing  
location of ISOFIX low  
anchorage points.**

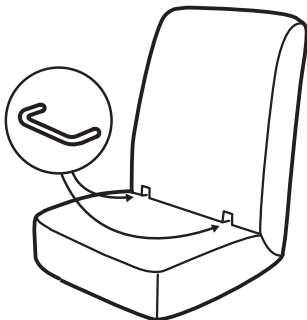

**LATCH**

See general installation instructions on page 23 & 24.

1 Some models come with guides for the ISOFIX compatible connectors. These are for use in cars where the anchorage bar is recessed a long way into the seats and once fitted will help guide the ISOFIX connector into place.

2 To use these:

- locate the position of the ISOFIX low anchorage,
- slide the guide in until it contacts the steel rod
- allow the guide to push up until it is secure on the steel rod.

3 Swing the ISOFIX compatible connectors forward to their operating position.

4 Attach each connector to the vehicle ISOFIX low anchorages.

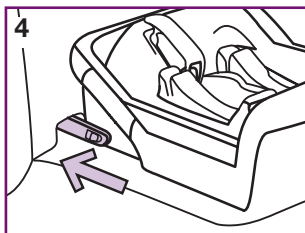
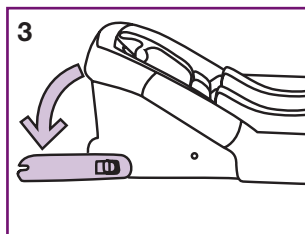
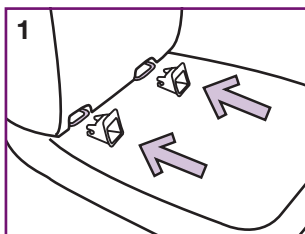

- 5 Pull the restraint forward to ensure both lower connectors are engaged.

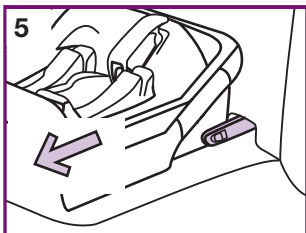

- 6 Check the bubble level indicator to see if recline level is still correct. Adjust if necessary.

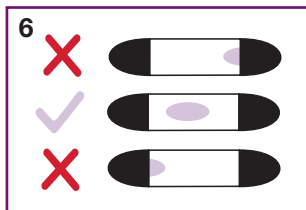

**! WARNING**

**IMPORTANT Do not attach the lower attachment connectors of two separate child restraints to the same ISOFIX low anchorage in your car.**

Always attach the top tether strap to the child restraint upper anchorage in your car.

Child restraint lower attachment connectors and the ISOFIX low anchorages in your car are designed to withstand only those loads imposed by a correctly fitted child restraint.

# Storage – ISOFIX Compatible Connectors

Store the ISOFIX compatible connectors by pressing the release button under the base and swinging them back until they are snugly alongside the base.

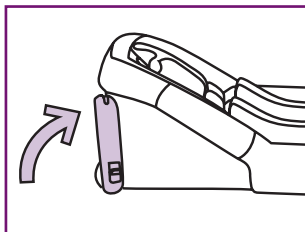
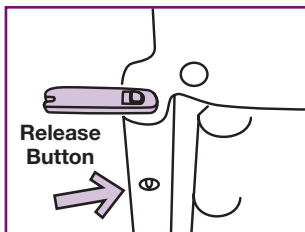



# Installation — Restraint to Base

## To Install

First make sure there is nothing in or on the base (blankets, toys etc). These may stop the restraint from latching in securely.

Lower the restraint down into the base. Listen for a "CLICK" from the latches in the base. Pull up on the restraint to ensure it is securely latched.

## To Release

Lift the restraint with one hand while pulling up on the release latch at the back of the base.

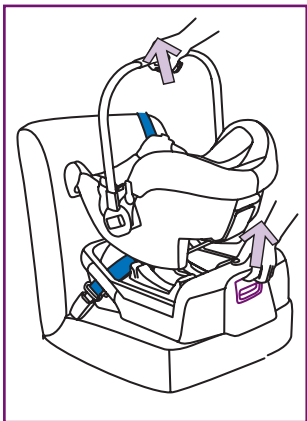
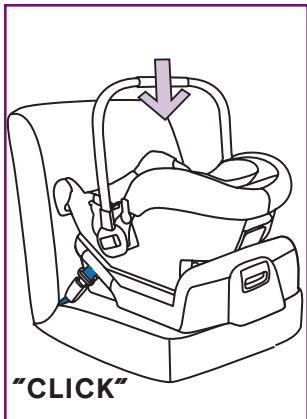



## **WARNINGS – Top Tether**

THIS RESTRAINT MUST BE ATTACHED TO A CHILD RESTRAINT UPPER ANCHORAGE POINT IN THE CAR.

REFER TO CAR OWNERS HANDBOOK FOR LOCATION OF ANCHORAGE POINTS.

REFER TO A CHILD RESTRAINT FITTING STATION IF NO ANCHORAGE POINTS ARE IN THE MOTOR CAR.

THIS RESTRAINT IS NOT SUITABLE FOR USE WHERE THE TOP TETHER STRAP MAY FALL INTO A SPLIT IN THE SEAT BACK OR OFF THE SIDE OF THE SEAT.

Always secure the loose end of the top tether strap to prevent it hanging out of the car or being accessible by the child.

It should be stored in the bag provided on the end of the strap.

Do not use the child restraint where this strap may fall into a split in the seat back or off the side of the seat.

**ALWAYS ATTACH HOOK AND REMOVE SLACK.**

**CAUTION: CHILDREN CAN BE INJURED OR RESTRAINTS AND TOP TETHER STRAP DAMAGED BY UNSECURED CARGO IN A COLLISION.**

**SECURE OR REMOVE HAZARDOUS CARGO BEFORE USING THIS CHILD RESTRAINT.**

In some vehicles without a fixed parcel shelf an extension tether strap may be required. These are available in several different lengths and can be obtained from child restraint retail outlets.

# Tether Strap — Use

This child restraint has a fixed tether strap permanently attached to the restraint, and an adjustable tether strap that can be removed and left in the vehicle.

Always use this tether strap.

Connect the tether strap to the built-in anchorage fitting in the vehicle, or if there is not one available, install the anchor fitting supplied with this restraint by following these instructions.

Store the extra webbing in the bag attached to the end of the tether.

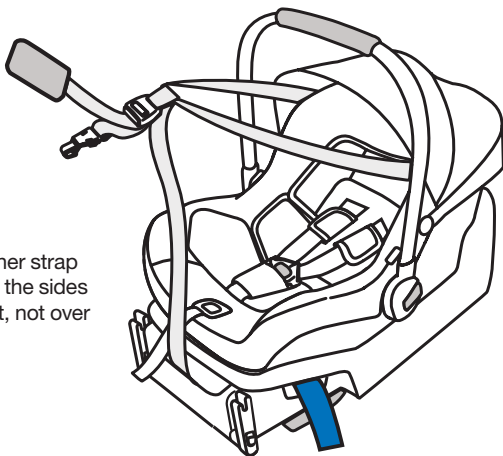

NOTE: the tether strap wraps around the sides of the restraint, not over the top.

# Installation — Tether Anchorage

Always connect the snap hook securely to the anchorage fitting.

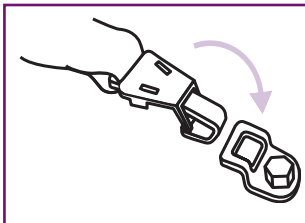

Adjust the tether tension until the webbing is pulled tight - but not so tight that it is lifting the child restraint off the vehicle seat.

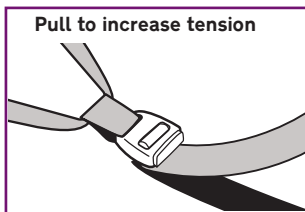

The anchor fitting must be aligned as shown unless stated otherwise in the vehicle owners handbook.

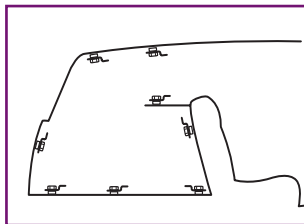

If drilling a new hole, select a position on the centre line of the seating position, and no closer than 100 mm from the front edge of the parcel shelf.

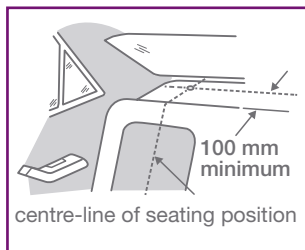

If the car is fitted with a child restraint anchorage point:

Locate the anchorage point behind the rear seating position (consult the vehicle owners handbook for location of the anchorage point). Remove the thread plug from the parcel shelf/floor/roof and install the attachment bolt as shown opposite.

**CAUTION:**  
DO NOT OVERTIGHTEN THE ATTACHMENT BOLT. MAXIMUM TORQUE 20Nm.

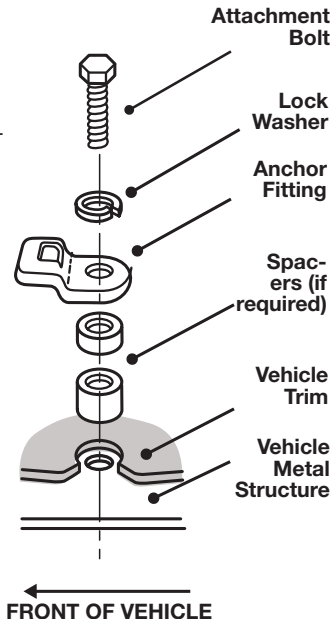

## **WARNING**

CHILD RESTRAINTS MUST NOT BE ATTACHED TO UNSOUND METAL OR WOOD OR SYNTHETIC STRUCTURES. WHEN DRILLING THE 9 MM HOLE DO NOT DRILL THROUGH FUEL LINES, FUEL TANKS, ELECTRICAL WIRING, OR RADIO SPEAKERS. WEBBING STRAPS MUST BE PROTECTED FROM SHARP CORNERS AND EDGES.

THE ANCHOR FITTING MUST BE USED ONLY AS DESCRIBED ABOVE. IT MUST NOT BE HOOKED ONTO ANY OTHER OBJECT.

If the car is not fitted with a child restraint anchorage point:

For sedans only - drill a 9 mm hole in the parcel shelf on the centre line of the seating position as shown on page 27.

Install the anchor bolt as shown opposite.

For vehicles other than sedans - In Australia, consult your nearest child restraint fitting station or traffic authority for vehicle inspection to find the best, correct position for the placement of the anchorage point, and for the correct attachment bolt length and use of spacers.

In New Zealand, consult the agent for the vehicle.

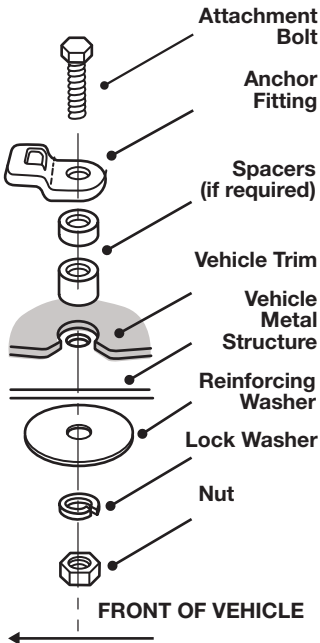

## Use with Strollers

PIPA™ car seat can attach to Nuna strollers using adapters. Instructions are included with the adapters, which are sold separately.

Please visit [www.babyhood.com.au](http://www.babyhood.com.au) for more information.

# Cleaning and Maintenance

## Seat Cover

Wash with cold water and mild detergent.

Do not iron.

Do not bleach or dry clean.

Do not twist the soft goods to dry with great force. It may leave the seat cover with wrinkles.

Hang dry the seat cover in the shade.

## Plastic and Metal Parts

Use only mild detergent, water and a soft cloth to clean the car seat shell, handle and harness straps. Air dry.

Do not use undiluted detergent, or other solvents to clean - these may cause damage.

## Harness Buckle

To clean the buckle: rinse using warm water. DO NOT use any soaps, solvents or lubricants. Using anything other than water can cause the buckle to malfunction. Air dry.

When the buckle is operating correctly the tongues will push in easily and the second tongue will CLICK when it latches into place.

If the buckle does not appear to be working correctly get it checked or replaced by contacting the retailer from where it was purchased, or by contacting Babyhood.



## **Harness Straps**

Either spot clean or replace. DO NOT IMMERSE THE HARNESS STRAPS IN WATER. NEVER iron the harness straps, doing so may weaken the harness straps.

## **Storage**

Remove the child restraint from the vehicle seat if not in use for a long period of time. Put the child restraint in a cool, dry place and somewhere your child cannot access it.



**Babyhood**

**132 Compton Road, Woodridge, 4114**

**Brisbane, Australia**

**Tel: 07 3208 3555**

**Fax: 07 3208 8691**

**email: [sales@babyhood.com.au](mailto:sales@babyhood.com.au)**

**web: [www.babyhood.com.au](http://www.babyhood.com.au)**